

FLUID HEADS

• Heavy Duty Fluid heads made of Aluminum are featured with Sliding Plate.

FHD-66AS/C and FHD-66AS/W

Smooth Fluid head but features Counter balance spring for the tilting. While unlocking the outer tilting stopper knob, seek for the centre bottom of the head may feel click to have the counter balance effects on. It prevents from sudden drop the camera due to its heavy weight by losing balance. Please use maximum 4kg loading weight on this head. And furthermore, in case of D-SLR user needs to have vertical position while taking movie, like portrait shots, the camera platform turns 90 degree.

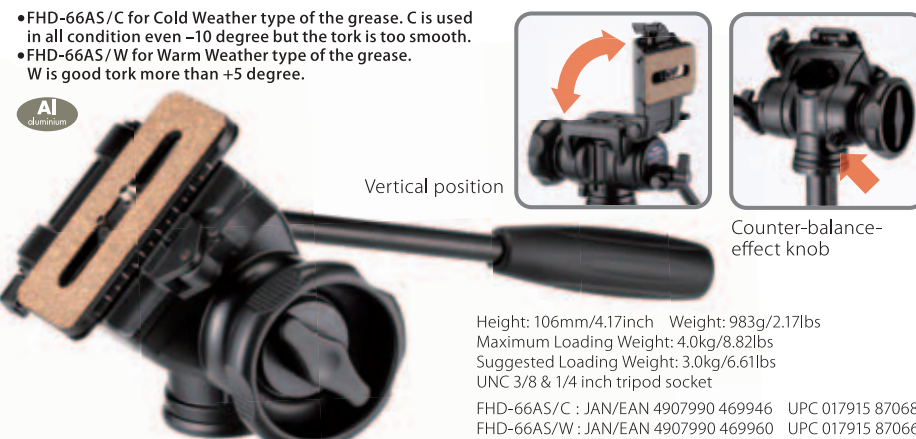

CAMERA BRACKETS

• NEW 3 type of camera bracket. BR-Q(for QRA-635L), BR-D(DIN TYPE), BR-M(Mini-D TYPE)



BR-Q

Compatible with Velbon QRA-635L, the best seller in Japan
L:108(4.25)xW:46(1.81)xH:89.5(3.52)mm(inch)
Weight:125g/0.28lbs
UNC 1/4 inch screw
JAN/EAN 4907990 391032
UPC 017915 980006

BR-Q, BR-D, BR-M

Normally when turning the camera to a vertical position on a tripod, all the settings including focus and framing need to be adjusted, however if you attach one of the new Velbon brackets to your camera body this allows you to maintain the center of focus and the centre of gravity of camera when changing from landscape to horizontal format.

*Please note--this bracket is not compatible with all makes of camera body

BR-D(DIN)

Compatible with the DIN standard quick release socket
L:107(4.21)xW:42(1.65)xH:72(2.83)mm(inch) Weight: 99g/0.22lbs
UNC 1/4 inch screw
JAN/EAN 4907990 391049
UPC 017915 988020

BR-M(Mini D-type)

Compatible with Velbon MINI-D Type
L:97(3.82)xW:32(1.26)xH:54(2.13)mm(inch) Weight: 62g/0.14lbs
UNC 1/4 inch screw
JAN/EAN 4907990 391056
UPC 017915 980044

LEVELER

ML-6

More precise level is necessary for movie and panorama shots. Use betweenhead and tripod to adjust on uneven terrain.

H: 46.8(1.84)mm(inch) Weight: 260g/0.57lbs
Diameter of the Pedestal: 55(2.17)mm(inch)
UNC 1/4 inch screw

JAN/EAN 4907990 473288 UPC 017915 950108



UTC SERIES [carbon fiber material]

The all-new Velbon UTC-63

UTC-63

The ultimate in flexibility, strength and lightweight

The UTC-63 carbon fibre tripod is extremely compact when folded yet extends to 4.3x its folded length, up to a maximum of 1.55 metres, making it an extremely versatile travel companion for low level or full height photography.

Mg
magnesium



QRP

C
carbon



UNC 1/4

Al
aluminium



Detachable



Spirit level included

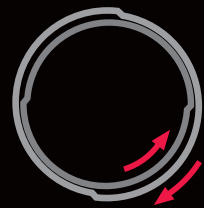

By twisting the leg end tip in the anti-clockwise direction, all leg sections are loosened and can be collapsed. Twisting leg end tip in the clockwise direction locks all leg sections with one action. Make sure all legs are locked tightly before mounting the camera. Inside pipes lock each other when twisted right or left.

CARBON FIBER + DIRECT CONTACT PIPE

UTC-63

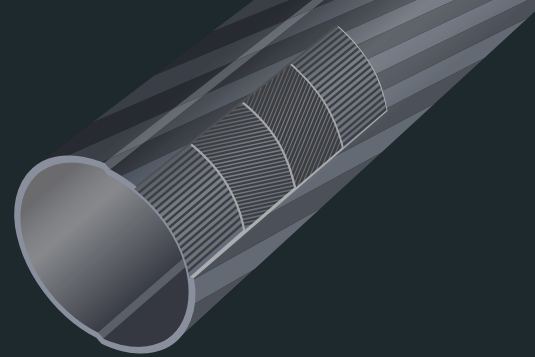

Standard angle position

Full low angle position

This series feature legs that fold by reversing through a full 180 degrees.

×4.3

Maximum Height
1550mm

Storage Size
360mm

	155.00
cm / inch	61.02
	135.50
cm / inch	53.35
	34.00
cm / inch	13.39
	36.00
cm / inch	14.17
	1.516
g / lbs	3.34
	4.50
Maximum Loading Weight	9.92
	2.50
Suggested Loading Weight	5.51
	28
mm / inch	1.10

UTC-63
ATTACHED HEAD / QHD-S6Q / QRA-635LII

FEATURES



1



2



3



4

1 2 Pull up the central leg adjuster to change the leg locking position. Twist it right to make legs non-reversible. This allows the leg angle to be changed to semi-low or full-low position for macro photography. **3** Leg angles can be opened from standard 25° to 45° and then to 75° step by step on each leg. Leg angle position can be cancelled by pushing to right. **4** Quick release plate slides in and is locked automatically by shoelever. Shoe lever can be further rotated for extra-sure locking.

GEO SERIES [carbon fiber material]

Next-generation carbon fiber and basalt formula for ultimate strength. The absolute pro spec Velbon.



PRO GEO V630

MAX cm / inch	171.00 67.32
cm / inch	128.70 50.67
cm / inch	12.70 5.00
kg / lbs	56.00 22.05
kg / lbs	1.596 3.52
kg / lbs	6.00 13.23
kg / lbs	4.00 8.82
Section mm / inch	28 1.10

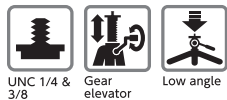

PRO GEO V640

MAX cm / inch	150.50 59.25
cm / inch	118.20 46.54
cm / inch	10.50 4.13
kg / lbs	43.50 17.13
kg / lbs	1.552 3.42
kg / lbs	6.00 13.23
kg / lbs	4.00 8.82
Section mm / inch	28 1.10

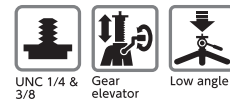

New locking system V-Lock

PRO GEO series features new V-Lock system leg locking devices. Stress-free, smooth actions for rotating pipe to release or lock the tripod leg extension. Newly designed grip and smaller locking nut enable compact folded length.



FEATURES



If the leg angle adjuster is inadvertently spread, push the cancel button to reset.

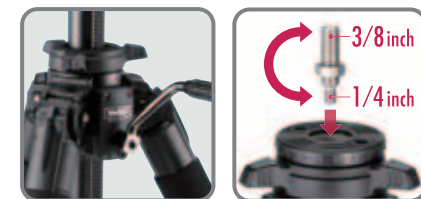

New Geared Crank system

Geared elevator helps you to up and down even heavy equipment on the tripod. Backlash of the geared elevator is prevented by our technical design in the gear box.

The screw has double threads. UNC 1/4 and 3/8 on the opposite ends.

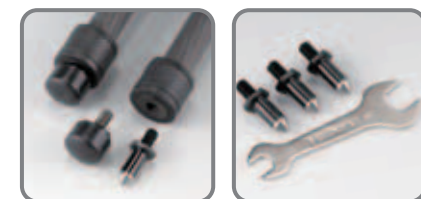

Optional spike feet

Spike feet are optional. Not included in the package.

PRO GEO V840BW

High-modulus carbon fiberlegs + Counter-balanced video head

4-Section carbon legs provide extremely low position to the ground level. Velbon's new V-Lock system will supply smooth extension and extra sturdiness for the light weight carbon legs. Tripod body is made from Magnesium alloy, features 3 steps flat angles. 75mm bowl is good for the fluid and counter balance head.



ATTACHED HEAD / FHD-81

- The 75mm ball diameter and large video pan head
- A counterbalance : The section-lessness
- Counterbalance area : 4.5~10.5kg (height of the gravitational centre 100mm)
- Torque change : The free or 3 section
- Mobile camera plate
- Level with an illumination
- The practicable temperature : -40°~+60°
- Weight : 2750g
- Suggested loading weight : 10kg
- Camera screw size : UNC 1/4 and 3/8

MAX cm / inch	166.00 65.35
cm / inch	64.00 25.19
cm / inch	57.10 22.44
cm / inch	48.00 18.89
cm / inch	33.30 13.11
kg / lbs	68.00 26.77
kg / lbs	5.110 11.27
kg / lbs	12.00 26.46
kg / lbs	10.00 22.05
Section mm / inch	36 1.42



FEATURES

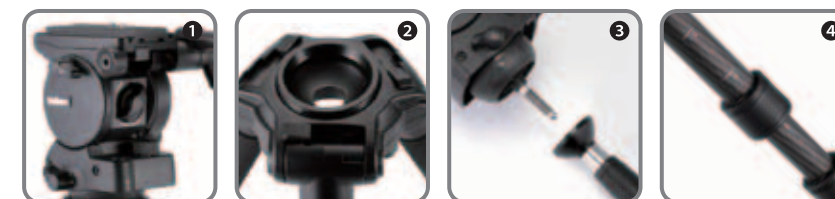

- 1 The head contains several friction controls.
- 2 The Bowl has 75mm diameter.
- 3 The head and the center column are connected with a M10 bolt.
- 4 High-modulus carbon fiber and basalt legs feature height indicators.



Maximum height

Full low angle position

SHERPA SERIES

Multi-function tripods

NEW SHERPA SERIES

New Sherpa range is for 5 triods and 1 monopod. Ball heads are for Sherpa 50 and 100. Good for travel compact and light weight. All Aluminum tripods with Low angle position is available by splitting the center column 2 sections. Sherpa 200 is fixed angle position but the traditional center column will be pulled out and upside down for macro photography. The best seller from Velbon for more than 15 years. Sherpa 300 and 400 have 3-way head with quick release plate and Low angle position. Sherpa 300 has the same head as Sherpa 200. PH-157Q 1-handle head, which is speedy for locking and releasing by one action. Best for the bird watching with Field scope. Sherpa 400 has heavy duty 2-handle panhead made from Magnesium alloy. Long zoom lens and D-SLR will be suitable for Sherpa 400. Every tripod from New Sherpa contains QRP (Quick Release Plate) and tripod carrying case.

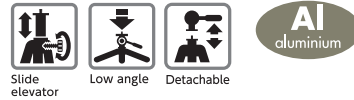

SHERPA 200/200R Ø26mm LEG

MAX 167.50 cm / inch	1.95 kg / lbs
65.94 cm / inch	4.30
137.50 cm / inch	4.00
54.13 cm / inch	8.82
60.00 cm / inch	3.00
23.62 cm / inch	6.61
62.00 cm / inch	26
24.41 cm / inch	1.02

ATTACHED HEAD
PH-157QK/
QB-157(DIN)

200R/
ATTACHED HEAD
PH-157Q/
QB-157(DIN)

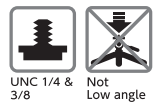

SHERPA 50 Ø20mm LEG

MAX 163.00 cm / inch	1.00 kg / lbs
64.17 cm / inch	2.20
134.00 cm / inch	2.50
52.76 cm / inch	5.51
19.30 cm / inch	1.50
7.60 cm / inch	3.31
51.00 cm / inch	20
20.08 cm / inch	0.79

ATTACHED HEAD
QHD-33M/
QB-42



SHERPA 100 Ø23mm LEG

MAX 161.50 cm / inch	1.40 kg / lbs
63.58 cm / inch	3.09
130.00 cm / inch	3.50
51.18 cm / inch	7.72
24.80 cm / inch	2.50
9.76 cm / inch	5.51
60.50 cm / inch	23
23.82 cm / inch	0.91

ATTACHED HEAD
QHD-43D/
QB-62(DIN)

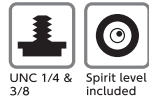

SHERPA 300 Ø26mm LEG

MAX 170.00 cm / inch	1.961 kg / lbs
66.93 cm / inch	4.32
135.30 cm / inch	4.00
53.27 cm / inch	8.82
28.20 cm / inch	3.00
11.10 cm / inch	6.61
63.00 cm / inch	26
24.80 cm / inch	1.02

ATTACHED HEAD
PH-157QK/
QB-157(DIN)



SHERPA 400 Ø29mm LEG

MAX 161.50 cm / inch	2.27 kg / lbs
63.58 cm / inch	5.01
139.50 cm / inch	6.00
54.92 cm / inch	13.23
29.70 cm / inch	3.50
11.69 cm / inch	7.72
67.00 cm / inch	29
26.38 cm / inch	1.14

ATTACHED HEAD
PHD-65D/
QB-62(DIN)

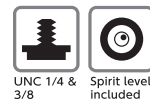

M SERIES

The new M series from Velbon is aimed at the travel photographer.

The series consists of three tripods: all feature 4-section legs however each tripod comes complete with the different head: a ball head, 3-way head and the 2-way fluid head.

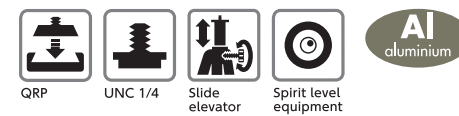

M43

• Ball head 4-section legs

Ball head made from new material, stability is just great. With QRP (quick release plate) Model No. QB-32. Tripod case included.

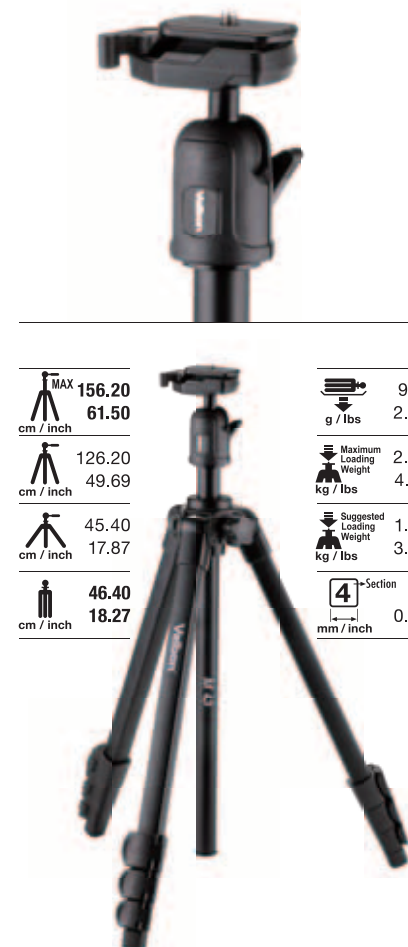

M45

• 3-way head, 4-section legs

3-way head with well-made Tilting stop by the handle grip. Panning, tilting and vertical are independently adjustable. With QRP (Quick Release Plate) Model No. QB-32. Tripod case included.

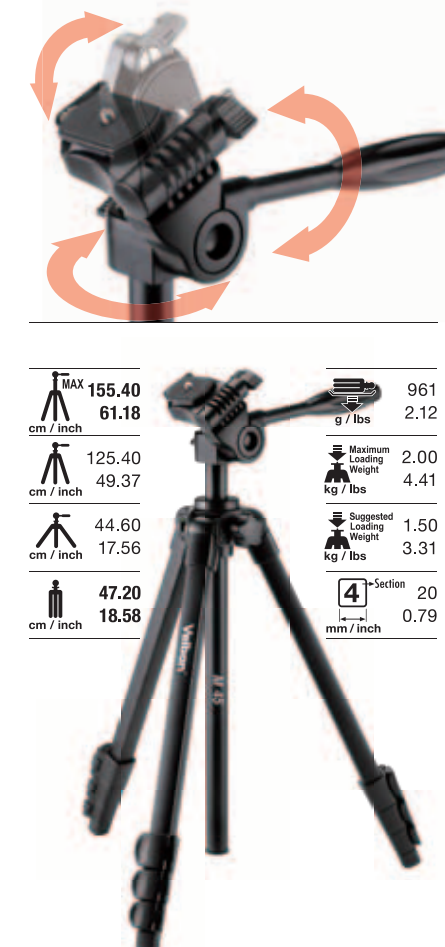

M47

• 2-way fluid head, 4-section legs

2-way fluid head with smooth action for adapting 4K camera. Also adaptable with a Binocular holder for the nature / bird watching. With QRP. Model No. QB-32. Tripod case included.



FEATURES (3 model commonness)

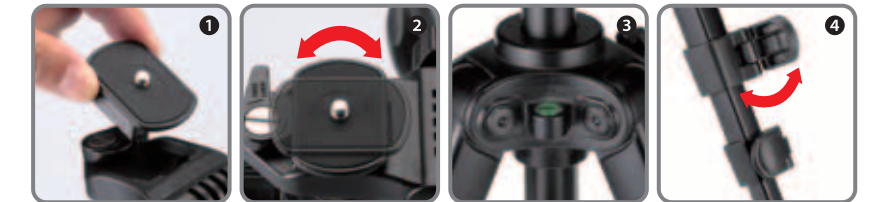

- 1 QRP (Quick Release Plate) mechanism QB-32
- 2 QB-32 MINI-D type QRP can be changed its direction because the base is just square.
- 3 Tripod body consists Bubble Leveler. Simple body without braces. The way how to swage the hinge, is so tight and can hold for a long term uses.
- 4 Quick lever locking for speedy extension.